

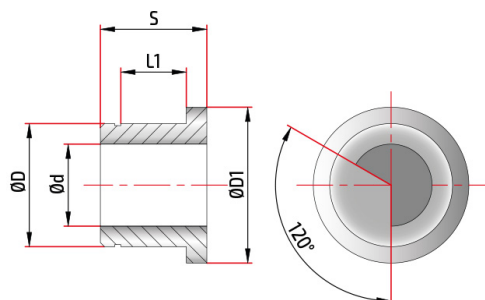

Visit the online
Product Sheet

PCA52000003

Rubber anti-vibrant drilling bushes D20



Details	Materials	Coatings
Drill diameter dp	2,20 - 2,29	Alternative Coatings
Tube diameter d	2,10	
Bush diameter D	20,00	
External diameter D1	26,00	
Thickness S	20,0	
Bearing seat l1	12,00	

This tool is available in diameters.

 Please consider the environment, before printing this document.