

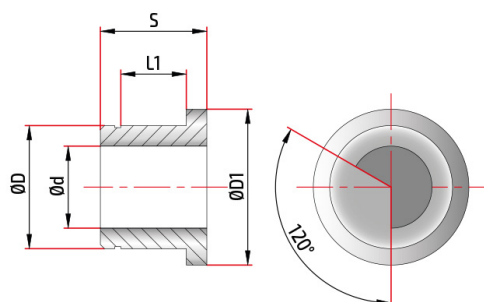

Visit the online Product Sheet

PCA52000024

Rubber anti-vibrant drilling bushes D20



Details	Materials	Coatings
Drill diameter dp	6,00 - 6,24	Alternative Coatings
Tube diameter d	5,75	
Bush diameter D	20,00	
External diameter D1	26,00	
Thickness S	20,0	
Bearing seat l1	12,00	

This tool is available in diameters.

 Please consider the environment, before printing this document.