

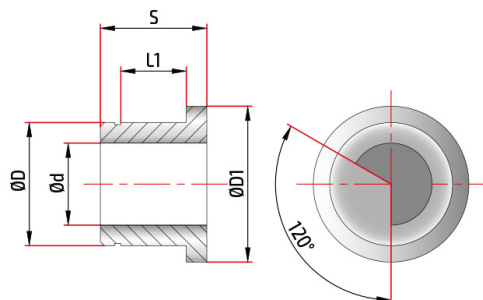

Visit the online Product Sheet

PCA52010035

Reinforced rubber anti-vibrant drilling bushes D20



Details	Materials	Coatings
Drill diameter dp	9,00 - 9,29	Alternative Coatings
Tube diameter d	8,70	
Bush diameter D	20,00	
External diameter D1	26,00	
Thickness S	20,0	
Bearing seat l1	12,00	

This tool is available in diameters.

Please consider the environment, before printing this document.