

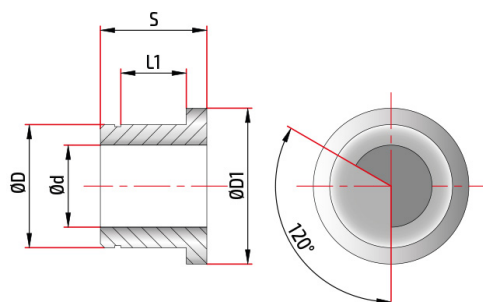

Visit the online Product Sheet

PCA53000031

Rubber anti-vibrant drilling bushes D30



Details	Materials	Coatings
Drill diameter dp	10,80 - 11,29	Alternative Coatings
Tube diameter d	10,50	
Bush diameter D	30,00	
External diameter D1	28,00	
Thickness S	26,0	
Bearing seat l1	16,00	

This tool is available in diameters.

Please consider the environment, before printing this document.