

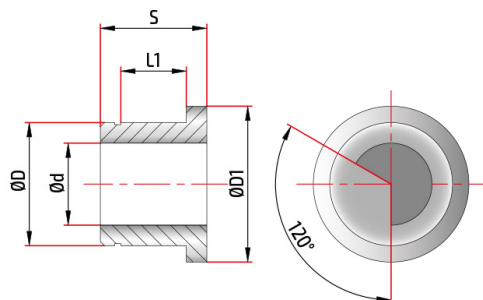

Visit the online Product Sheet

PCA53010015

Reinforced rubber anti-vibrant drilling bushes D30



Details	Materials	Coatings
Drill diameter dp	6,00 - 6,24	Alternative Coatings
Tube diameter d	5,75	
Bush diameter D	30,00	
External diameter D1	28,00	
Thickness S	26,0	
Bearing seat l1	16,00	

This tool is available in diameters.

Please consider the environment, before printing this document.