

 Visit the online Product Sheet

PCA54500025

Rubber anti-vibrant drilling bushes D45

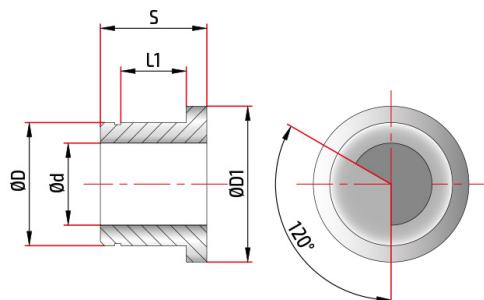

Details	Materials	Coatings
Drill diameter dp	9,00 - 9,29	Alternative Coatings
Tube diameter d	8,70	
Bush diameter D	45,00	
External diameter D1	50,00	
Thickness S	26,0	
Bearing seat l1	16,00	

This tool is available in diameters.

 Please consider the environment, before printing this document.