

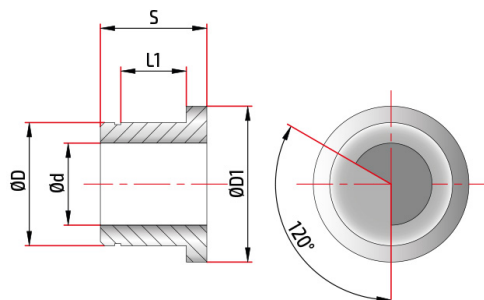

Visit the online Product Sheet

PCA54500043

Rubber anti-vibrant drilling bushes D45



Details	Materials	Coatings
Drill diameter dp	18,40 - 19,80	Alternative Coatings
Tube diameter d	18,00	
Bush diameter D	45,00	
External diameter D1	50,00	
Thickness S	26,0	
Bearing seat l1	16,00	

This tool is available in diameters.

Please consider the environment, before printing this document.